

# ARCSOURCE™ INGROUND 24MC INTEGRAL

Difficult inground installations are made easier with the ArcSource Inground 24MC Integral. The fixture only requires mains power when combined with the wireless control capability – drastically reducing installation time and cost. High light output comes from six powerful Multichip LEDs and it can be used with a variety of optics, from narrow to wide, in addition to an asymmetrical option. The light source can be remotely tilted  $\pm 15^\circ$  from the horizontal position, always ensuring accurate illumination of the selected surface. Additionally, ArcSource Inground 24MC Integral can be equipped with anti-skid glass featuring the highest standards of certification for anti-slip usage having no impact on the fixture's outstanding colour mixing.



## KEY FEATURES

Inground light source – integrated electronics & remote adjustable beam position.

### Lumen Output & Light Source

Providing perfectly mixed colour with luminous flux up to 1,542 lm, the 65 W ArcSource Inground 24MC Integral luminaire utilises RGBW LED Multi-chips with  $7^\circ$  optics. Its excellent lumen maintenance of 90,000 hrs (L90B10) provides a dependable and long-term lighting installation.

### Physical

Protected underground by high-pressure, die-cast aluminum, the above-ground stainless steel and glass cover provides an elegant and durable lighting solution in all kind of weather. The glass cover can be clear or with anti-skid treatment for inground applications, and its durability is guaranteed by IP68 and IK10 certification.

## COLOURS

\* UPON REQUEST



RGBW



RGBA



Pure White



Tuneable White \*

## COLOUR TEMPERATURE

\* UPON REQUEST



3.000 K



3.000 K  
-  
6.500 K \*

## CONTROL & PROTOCOLS



DMX RDM



WIRELESS DMX

OPTIONAL

## OPTIC OPTIONS

### CLEAR GLASS



7°



24°



34°



7°x42°



42°x7°

## STANDARD & SPECIFICATION



IP68



IK10



CE



ETL US



ROHS



UK CA



5 YEAR

Warranty with Registration

### ANTI-SKID GLASS



16°



28°



33°



16°x42°



42°x16°

## FINISH OPTIONS



Stainless Steel

# SPECIFICATION SHEET

## ARCSOURCE INGROUND 24MC INTEGRAL

### ARCSOURCE INGROUND 24MC INTEGRAL SPECIFICATION

<b>ELECTRICAL</b>	Input Voltage	100 - 277 V AC 50/60 Hz			
	Typical Power Consumption	65 W @ 230 V			
<b>OPTICAL</b>	Light Source	6 x 15 W Multichip LEDs			
	Colour Variants	RGBW (W - 6500 K), RGBA, PW (W - 3000 K)			
		Upon Request TW (3000 - 6500 K)			
	Beam Angle	Clear Glass	<b>Symmetrical:</b> 7°   24°   34°	<b>Bi-symmetrical:</b> 7°x 42°   42°x 7°	
		Anti-Skid Glass	<b>Symmetrical:</b> 16°   28°   33°	<b>Bi-symmetrical:</b> 16°x 42°   42°x 16°	
	Lumen Output Delivered	Clear Glass	1.542 lm	RGBW 7° W - 6500 K, all LEDs on full	
Anti-Skid Glass		1.297 lm	RGBW 16x42° W - 6500K, all LEDs on full		
Projected Lumen Maintenance	L90B10 >90.000 hrs, Ta = 25°C / 77°F				
<b>CONTROL</b>	Wireless DMX (Option)	Lumen Radio CRMX Technology			
	Interface Protocol	USITT DMX 512, RDM			
	Control System	ArcControl range or any Third Party DMX Controllers			
	Operating Modes	DMX, Master/Slave, Stand-alone			
	Programs / Functions / Features	Editable Program: 3 (up to 40 steps each)			
	Settings / Addressing	Via RDM communicator or Robe Universal Interface (RUNIT)			
	Power Supply	Integrated			
<b>PHYSICAL</b>	Width x Height x Depth	ø320 x 400 mm (ø12.6 x 15.75 in.)			
	Weight	18.2 kg   40.1 lbs	9 kg   19.8 lbs ArcSource Inground	9.2 kg   20.3 lbs Sleeve	
	Housing	High Pressure Die-Cast Aluminium Body - Stainless Steel Flange		Tempered Glass	
	Cables / Connections	Integral Junction Box			
	Mounting Method	External Sleeve			
	Adjustability	Motorized Tilt +/- 15°			
	Protection Factor   IK Rating	IP68 (1 m / 3.28 ft/ 8hrs) / Suitable For Wet Locations		IK10	
	Static Load Resistance	35 kN (surface ø10 cm load)			
	Cooling System	Convection			
	Operating Ambient Temperature	-20 °C / +40 °C (-4 °F / +104 °F)			
	Operating Temperature	+55 °C @ Ambient +40 °C (+131 °F @ Ambient +104 °F)			
	<b>CERTIFICATION</b>	Listings	ETL / cETL, CE, RoHS, UKCA		
Anti - Skid Glass Certification		UNE ENV12633 (Class 3), DIN 51130 (R-12), DIN 51097 (Class B), ASTM C 1028-07 (DRY: ≥ 0,7, WET: ≥ 0,6), EN101:91 MOHS (4-Point scale)			

### DIMENSIONS

ArcSource Inground 24MC Integral

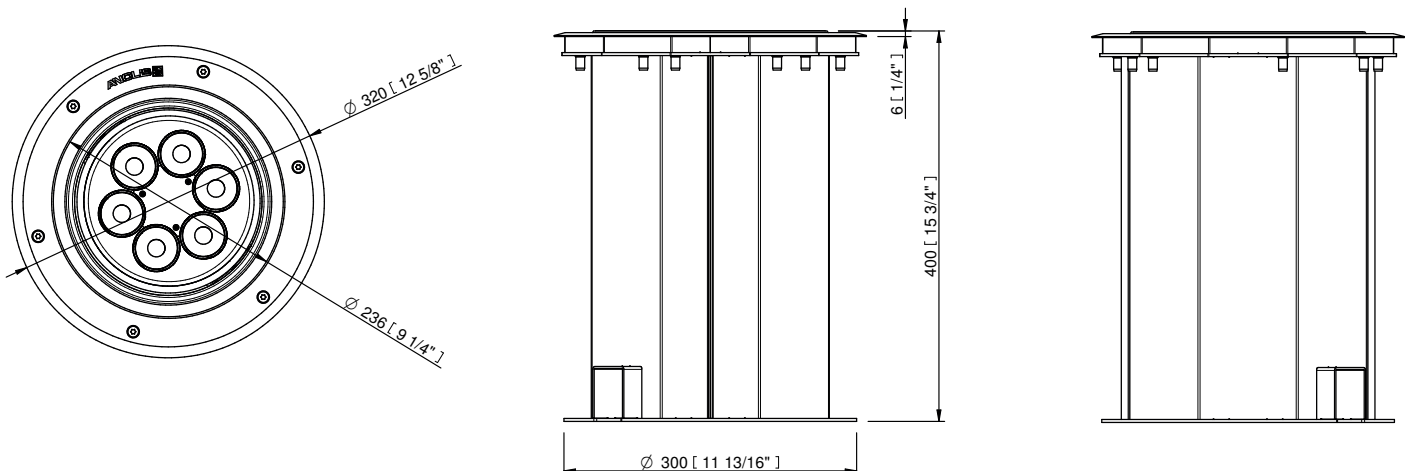

PHOTOMETRIC OVERVIEW

Lumen Output (lm) - Clear Glass

	RGBW (6500 K)	RGBA	PW (3000 K)
7°	1542	1361	1542
24°	1353	1194	1353
34°	1271	1122	1271
42° x 7°, 7° x 42°	1500	1324	1500

Lumen Output (lm) - Anti-Skid

	RGBW (6500 K)	RGBA	PW (3000 K)
16°	1143	1009	1143
28°	1028	907	1028
33°	1078	951	1078
16° x 42°   42° x 16°	1297   1217	1144   1074	1297   1217

BI-SYMMETRICAL BEAM ANGLES

Horizontal Ellipse  
7° x 42° (Clear Glass)  
16° x 42° (Anti-Skid Glass)

Vertical Ellipse  
42° x 7° (Clear Glass)  
42° x 16° (Anti-Skid Glass)

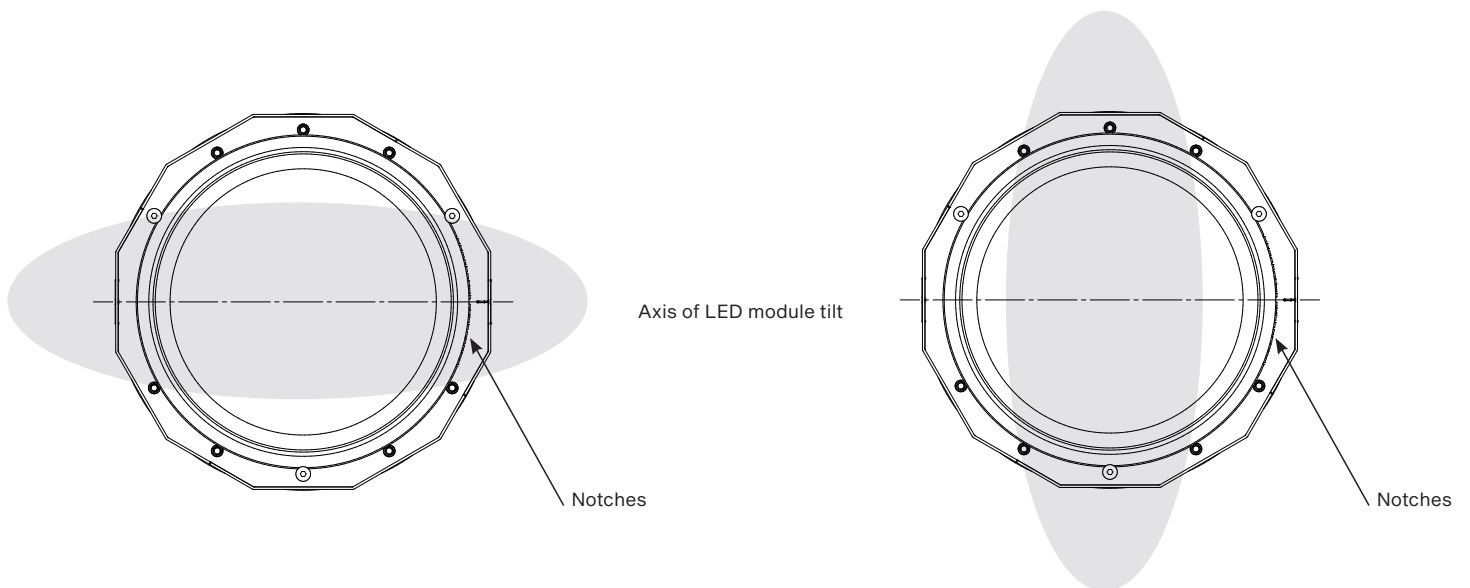

PHOTOMETRIC DATA

ArcSource Inground 24MC Integral  
RGBCW 7dg with Clear Glass

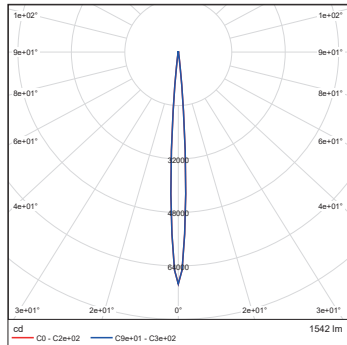

ArcSource Inground 24MC Integral  
RGBCW 24dg with Clear Glass

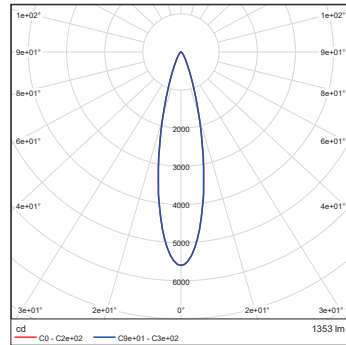

ArcSource Inground 24MC Integral  
RGBCW 34dg with Clear Glass

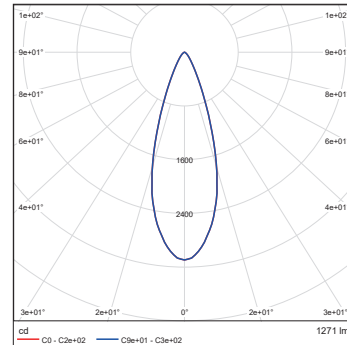

ArcSource Inground 24MC Integral  
RGBCW 7dg x 42dg with Clear Glass

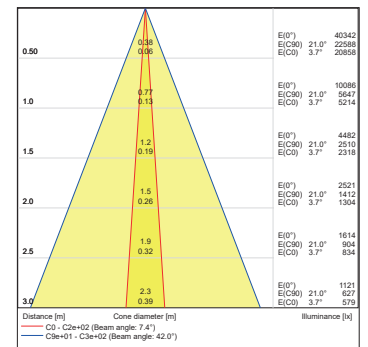
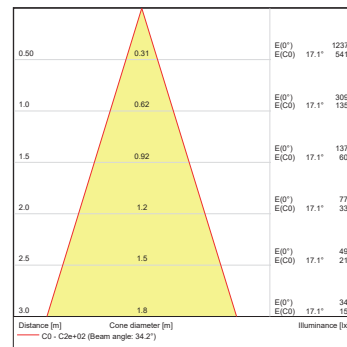
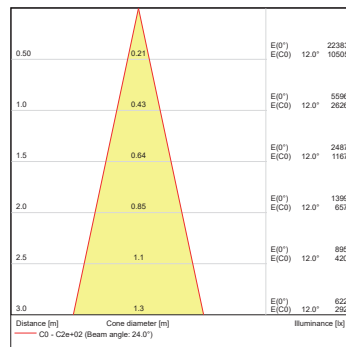
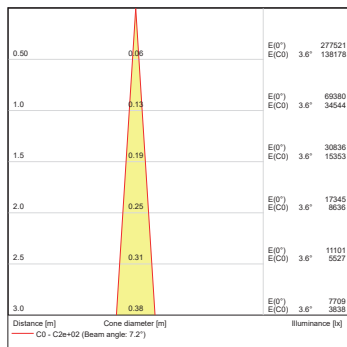
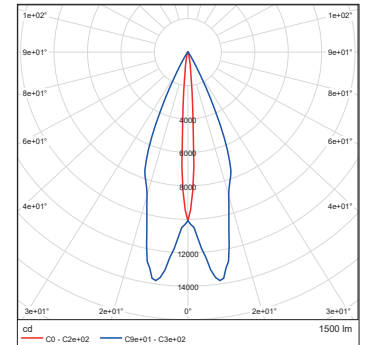

ArcSource Inground 24MC Integral  
RGBCW 42dg x 7dg with Clear Glass

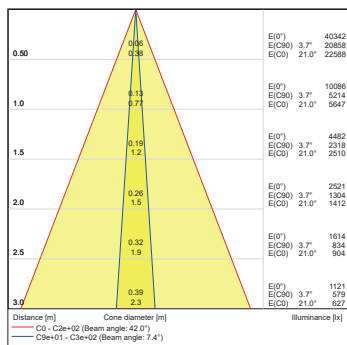
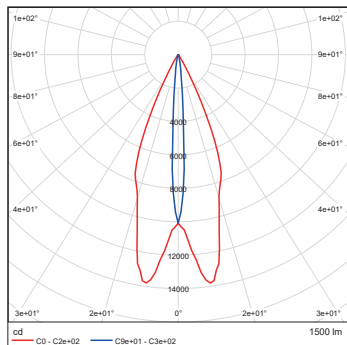

PHOTOMETRIC DATA

ArcSource Inground 24MC Integral  
RGCW 16dg with Anti-Skid Glass

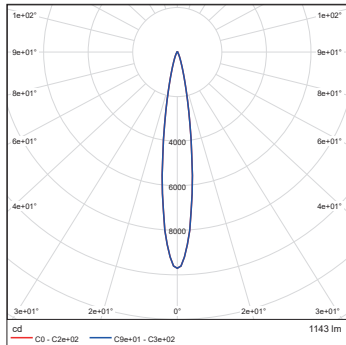

ArcSource Inground 24MC Integral  
RGCW 28dg with Anti-Skid Glass

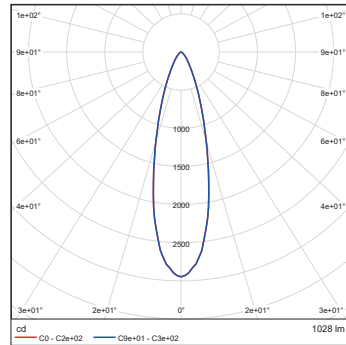

ArcSource Inground 24MC Integral  
RGCW 33dg with Anti-Skid Glass

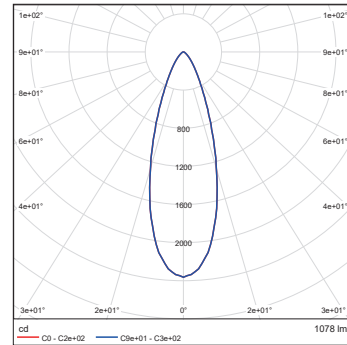

ArcSource Inground 24MC Integral  
RGCW 16dg x 42dg with Anti-Skid  
Glass

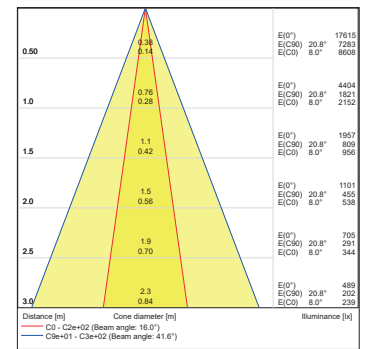
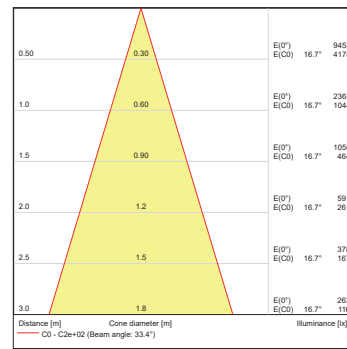
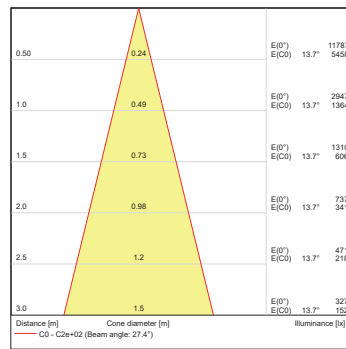
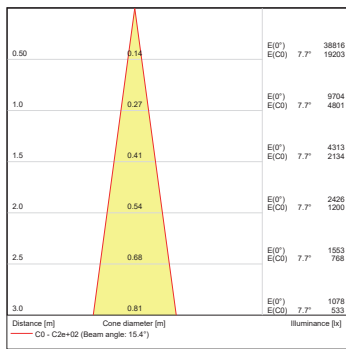
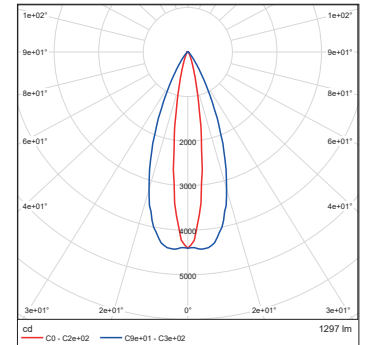

ArcSource Inground 24MC Integral  
RGCW 42dg x 16dg with Anti-Skid  
Glass

